

Preform 29-21 - 23 g

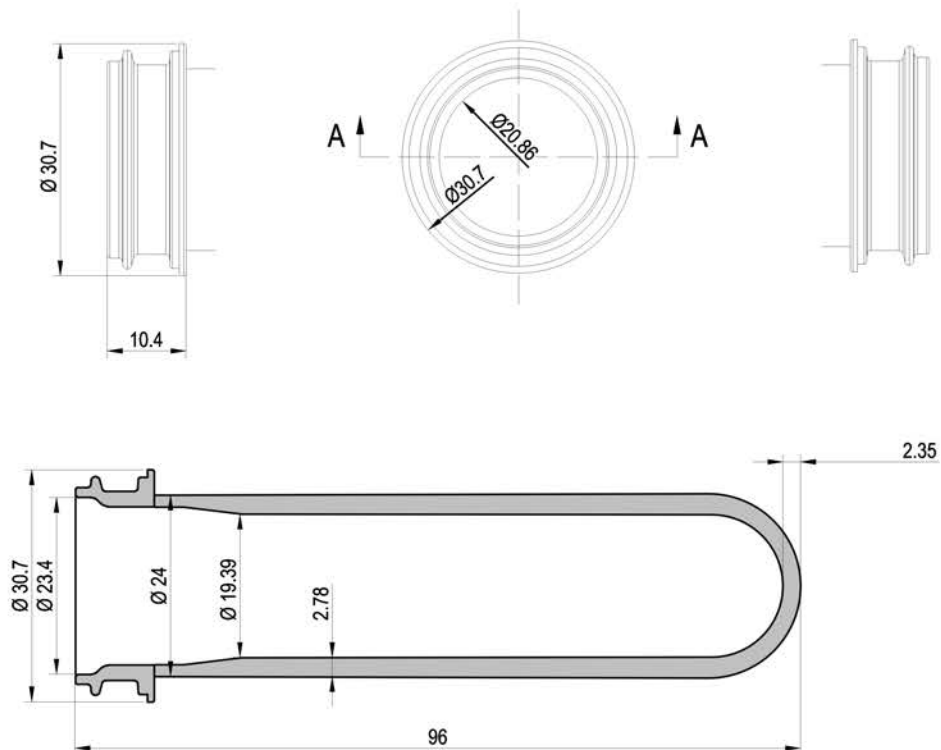

TECNICAL SPECIFICATION

DESCRIPTION	PREFORM 29-21 - 23 g
NECK TYPE	"29-21 mm"
WEIGHT	23 g
NECK WEIGHT	2.6 g



MATERIAL PET / R - PET

SPECIFIC WIEGHT 1.335 g/cm²

PACKAGING Pallet 100x120 cm - 120x120 cm
Octabin 120x120x118 cm - 100x120x118 cm
Polyethylene bag 200x250 cm - 190+20+20x250 cm

STORAGE Store the product in a dry place not exposed to sunlight
Maximum number of stackable Octabins 3
Before use, store for 24 hours in a room at a temperature between 18 ° -40 ° C
Use the product within 12 months from the date of receipt

NOTE